

TPS6123x 具有 5A 开关的高效同步升压转换器

1 特性

- 输入电压范围：2.3V 至 5.5V
- 输出电压范围：2.5V 至 5.5V
- 同步升压转换器效率高达 96%
- 输出电流 2.1A 的 3.3V 至 5V 电源转换
- 带有可调阈值/滞后的输入电源电压监控器
- 用于在轻载时实现高效率的省电模式
- 关断期间负载断开
- 输出过压保护
- 可编程软启动
- 电源正常输出
- 2MHz 开关频率
- 输出电容器放电 (TPS61231)
- 3mm x 3mm x 0.9mm 超薄小外形尺寸无引线 (VSON) 封装

2 应用范围

- 低压锂离子电池供电类产品
- USB 电源
- 平板电脑
- 移动电源、备用电池
- 工业仪表计量设备

3 说明

TPS6123x 器件系列是一款采用紧凑解决方案尺寸的高效同步升压转换器。它针对由单节锂离子电池或 3.3V 稳压电源轨供电的产品进行了优化。集成电路 (IC) 中集成了一个 5A 开关，并且能够在由 3.3V 输入电源供电，输出电压为 5V 时传送高达 2.1A 的输出电流。此器件基于准恒定接通时间谷值电流模式控制机制。典型运行频率为 2MHz，这样可使用小型电感器和电容器来实现小解决方案尺寸。TPS61230 和 TPS61231 通过一个外部电阻分压器提供可调输出电压，而 TPS61232 提供 5V 的固定输出电压。

轻负载期间，TPS6123x 自动进入省电模式，以最低静态电流实现最大效率。在关断期间，负载完全从输入上断开，并且输入流耗减少至 1.5 μ A (典型值)。此器件集成一个精密低功率 EN 比较器。EN 阈值以及使能比较器的滞后可由外部电阻器调节，并且支持应用专用系统加电和断电要求。还内置了其他诸如输出过压保护、热关断保护和电源正常输出等特性。

此器件采用 3mm x 3mm x 0.9mm VSON 封装。

器件信息⁽¹⁾

部件号	封装	封装尺寸 (标称值)
TPS61230	超薄小外形尺寸无引线 (VSON) (10)	3.00mm x 3.00mm
TPS61231 ⁽²⁾		
TPS61232		

(1) 如需了解所有可用封装，请见数据表末尾的可订购产品附录。

(2) 产品预览。有关更多信息，请联系 TI 厂家

TPS61230 典型应用

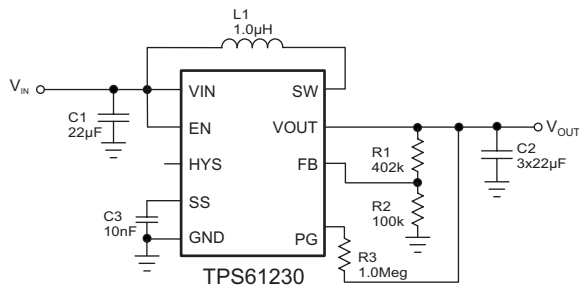

TPS61230 典型应用效率

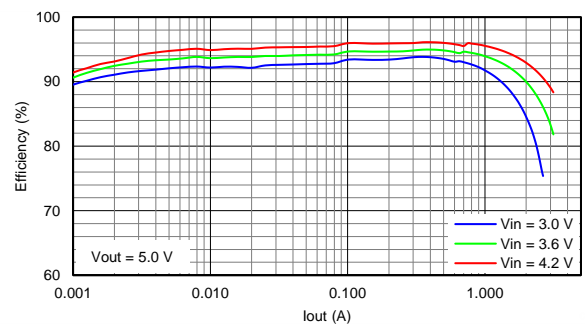

目录

1	特性	1	8.4	Device Functional Modes	11
2	应用范围	1	9	Applications and Implementation	12
3	说明	1	9.1	Application Information	12
4	修订历史记录	2	9.2	Typical Applications	12
5	Device Comparison Table	3	10	Power Supply Recommendations	20
6	Pin Configuration and Functions	3	11	Layout	21
7	Specifications	4	11.1	Layout Guidelines	21
7.1	Absolute Maximum Ratings	4	11.2	Layout Example	21
7.2	Handling Ratings	4	11.3	Thermal Considerations	21
7.3	Recommended Operating Conditions	4	12	器件和文档支持	23
7.4	Thermal Information	4	12.1	器件支持	23
7.5	Electrical Characteristics	5	12.2	文档支持	23
7.6	Typical Characteristics	6	12.3	相关链接	23
8	Detailed Description	8	12.4	商标	23
8.1	Overview	8	12.5	静电放电警告	23
8.2	Functional Block Diagram	8	12.6	术语表	23
8.3	Feature Description	8	13	机械封装和可订购信息	23

4 修订历史记录

Changes from Revision B (June 2014) to Revision C Page

•	已更改 Electrical Characteristics in the I_Q row; $V_{OUT} = 3.5\text{ V}$ to $V_{OUT} = \text{No Supply}$	5
---	---	----------

Changes from Revision A (March 2014) to Revision B Page

•	已将 TPS61232 添加到数据表	1
•	已更改器件信息	1
•	Changed the Device Comparison Table	3
•	Changed the Handling Ratings table	4

Changes from Original (September 2013) to Revision A Page

•	已从数据表中删除 TPS61232	1
•	已将数据表更改为全新的 TI 格式	1
•	已将说明从: 输入流耗减少至 $0.5\mu\text{A}$ (典型值) 更改为: 输入流耗减少至 $1.5\mu\text{A}$ (典型值)	1
•	Changed the Functional Block Diagram. Removed Note 2	8
•	Deleted the Programming The Output Voltage section	13
•	Changed 图 14 label From: Startup (A) To: Startup (Ω)	15

5 Device Comparison Table

PART NUMBER	OUTPUT VOLTAGE	OUTPUT DISCHARGE
TPS61230DRC	Adjustable	No
TPS61231DRC ⁽¹⁾	Adjustable	Yes
TPS61232DRC	5-V fixed output	No

(1) Preview product. Contact TI factory for more information

6 Pin Configuration and Functions

**11-PIN VSON
DRC PACKAGE
(Top View)**

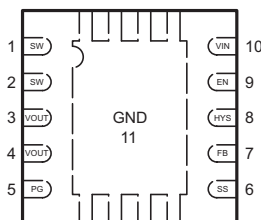

Pin Functions

PIN		I/O	DESCRIPTION
NAME	NUMBER		
SW	1,2	PWR	The switch pin of the converter. It is connected to the drain of the internal Power MOSFETs.
VOUT	3,4	PWR	Boost converter output pin.
PG	5	OUT	Power Good open drain output. Can be left floating if not used.
SS	6	IN	Soft startup pin. A soft startup capacitor connects to this pin to set the soft start time.
FB	7	IN	Voltage feedback of adjustable versions. Must be connected to VOUT on fixed output voltage version.
HYS	8	OUT	EN hysteresis program pin. See the application section for details. Can be left floating if not used.
EN	9	IN	Enable logic input. Logic HIGH enables the device. Logic LOW disables the device and turns it into shutdown mode. This pin must be terminated.
VIN	10	IN	Supply voltage pin.
GND	11	PWR	Ground pin.

7 Specifications

7.1 Absolute Maximum Ratings

over operating free-air temperature range (unless otherwise noted)⁽¹⁾

		MIN	MAX	UNIT
Voltage range at pins ⁽²⁾	EN, FB, PG, SS, HYS, VIN, VOUT, SW	-0.3	7	V
Operating junction temperature range, T _J		-40	150	°C

- (1) Stresses beyond those listed under *absolute maximum ratings* may cause permanent damage to the device. These are stress ratings only, and functional operation of the device at these or any other conditions beyond those indicated under *recommended operating conditions* is not implied. Exposure to absolute-maximum-rated conditions for extended periods may affect device reliability.
- (2) All voltages are with respect to network ground pin.

7.2 Handling Ratings

		MIN	MAX	UNIT	
T _{stg}	Storage temperature range	-65	150	°C	
V _{ESD}	Electrostatic discharge	Human body model (HBM), per ANSI/ESDA/JEDEC JS-001, all pins ⁽¹⁾	-2	2	kV
		Charged device model (CDM), per JEDEC specification JESD22-C101, all pins ⁽²⁾	-500	500	V

- (1) JEDEC document JEP155 states that 500-V HBM allows safe manufacturing with a standard ESD control process.
- (2) JEDEC document JEP157 states that 250-V CDM allows safe manufacturing with a standard ESD control process.

7.3 Recommended Operating Conditions

		MIN	TYP	MAX	UNIT
V _{IN}	Supply voltage at VIN pin	2.3		5.5	V
I _{SINK_PG}	Sink current at PG pin			500	μA
V _{PG}	Pull-up resistor voltage			5.5	V
T _J	Operating junction temperature	-40		125	°C

7.4 Thermal Information

THERMAL METRIC ⁽¹⁾		TPS6123x		UNIT
		DRC (11 PINS)		
R _{θJA}	Junction-to-ambient thermal resistance	49.1		°C/W
R _{θJC(top)}	Junction-to-case(top) thermal resistance	57.2		
R _{θJB}	Junction-to-board thermal resistance	26.6		
Ψ _{JT}	Junction-to-top characterization parameter	0.8		
Ψ _{JB}	Junction-to-board characterization parameter	23.8		
R _{θJC(bottom)}	Junction-to-case(bottom) thermal resistance	4.5		

- (1) For more information about traditional and new thermal metrics, see the *IC Package Thermal Metrics* application report, [SPRA953](#).

7.5 Electrical Characteristics

 $T_J = -40^{\circ}\text{C}$ to 125°C and $V_{IN} = 3.6\text{ V}$. Typical values are at $T_J = 25^{\circ}\text{C}$, unless otherwise noted.

PARAMETER		TEST CONDITIONS	MIN	TYP	MAX	UNIT
SUPPLY						
V_{UVLO}	Input under voltage lockout	V_{IN} falling		2.0	2.1	V
		V_{IN} rising		2.1	2.2	
I_Q	Quiescent current into VIN	IC enabled, No load, No switching $V_{OUT} = 5\text{ V}$, $T_J = -40^{\circ}\text{C}$ to 85°C		35	60	μA
		IC enabled, No load $V_{IN} = 4.2\text{ V}$, $V_{OUT} = \text{No supply}$, $T_J = -40^{\circ}\text{C}$ to 85°C		200	230	
I_{SD}	Shutdown current into VIN	$0\text{ V} \leq V_{EN} \leq 0.4\text{ V}$, $V_{IN} = 2.3\text{ V}$ to 5.5 V , $T_J = -40^{\circ}\text{C}$ to 85°C		1.5	6	μA
	Leakage current from SW to VOUT	$V_{EN} = 0\text{ V}$, $V_{OUT} = 0\text{ V}$; $V_{SW} = V_{IN} = 3.6\text{ V}$			2.5	μA
OUTPUT						
V_{OUT}	Output voltage range		2.5		5.5	V
V_{OUT}	Output voltage accuracy, TPS61232	PWM mode	4.9	5.0	5.1	V
V_{OUT}	Output voltage accuracy, TPS61232	PFM mode ⁽¹⁾		5.035		V
V_{FB}	Feedback voltage, TPS61230 and TPS61231	PWM mode	0.985	1	1.015	V
		PFM mode ⁽¹⁾		1.007		
	FB pin leakage current	$V_{FB} = 1\text{ V}$			100	nA
R_{DIS}	Output discharge resistor TPS61231	$V_{OUT} = 5\text{ V}$		200		Ω
V_{OVP}	Over voltage protection DC threshold	V_{OUT} rising	5.7	6	6.2	V
	Over voltage protection hysteresis	V_{OUT} falling below V_{OVP}		0.15		
I_{SS}	Bias current in soft start phase	After pre-charge phase		5		μA
	Line regulation	$I_{OUT} = 1\text{ A}$, $V_{IN} = 2.3\text{ V}$ to 4.5 V		0.06		%/V
	Load regulation	$I_{OUT} = 0.5\text{ A}$ to 2 A		0.15		%/A
LOGIC INTERFACE						
$V_{TH_EN_ON}$	EN pin threshold rising	$V_{IN} = 2.3\text{ V}$ to 5.5 V	1.15	1.19	1.23	V
$V_{TH_EN_OF}$	EN pin threshold falling	$V_{IN} = 2.3\text{ V}$ to 5.5 V	1.11	1.14	1.18	V
V_{OL_HYS}	HYS pin low level voltage	$I_{SINK_HYS} = 1\text{ mA}$, $V_{EN} = 1.1\text{ V}$			0.7	V
V_{TH_PG}	Power good DC threshold	V_{OUT} rising, referenced to $V_{OUT_NOMINAL}$	93%	95%	99%	
		V_{OUT} falling referenced to $V_{OUT_NOMINAL}$	87%	90%	93%	
V_{OL_PG}	PG pin low level voltage	$I_{SINK_PG} = 500\text{ }\mu\text{A}$			0.4	V
POWER STAGE						
I_{LIM_SW}	Switch valley current limit		4.0	5.0	6.0	A
I_{LIM_Pre}	Precharge current limit	$V_{OUT} = 5\text{ V}$	2.0	2.8	3.5	A
		$V_{OUT} = 3.5\text{ V}$	1.8	2.6	3.3	
		$V_{OUT} = 0\text{ V}$	0.4	0.55	0.7	
$R_{DS(on)}$	High side MOSFET on resistance	$V_{OUT} = 5\text{ V}$		50	75	m Ω
	Low side MOSFET on resistance	$V_{OUT} = 5\text{ V}$		50	75	
T_{JSD}	Thermal shutdown threshold	T_J rising		150		$^{\circ}\text{C}$
	Thermal shutdown hysteresis	T_J falling below T_{JSD}		20		

(1) $L = 1\text{ }\mu\text{H}$, $C_{OUT} = 20\text{ }\mu\text{F}$ (effective capacitance value)

7.6 Typical Characteristics

$V_{IN} = 3.6\text{ V}$, $V_{OUT} = 5.0\text{ V}$, $T_J = -40^\circ\text{C}$ to 125°C , unless otherwise noted.



图 1. High-Side MOSFET On Resistance vs Junction Temperature



图 2. Low-Side MOSFET On Resistance vs Junction Temperature

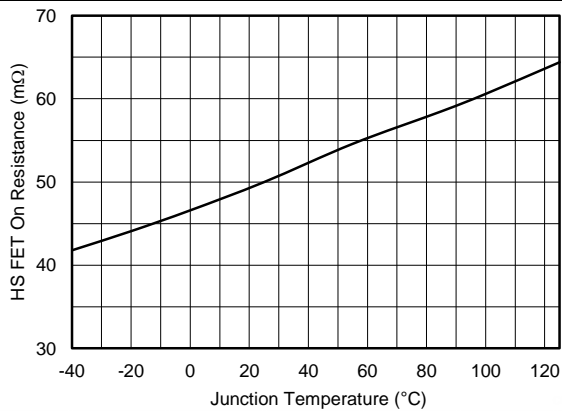

图 3. Voltage Reference vs Junction Temperature

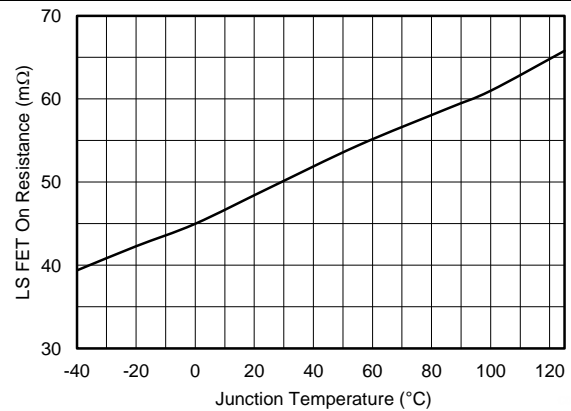

图 4. Vin UVLO Threshold vs Junction Temperature

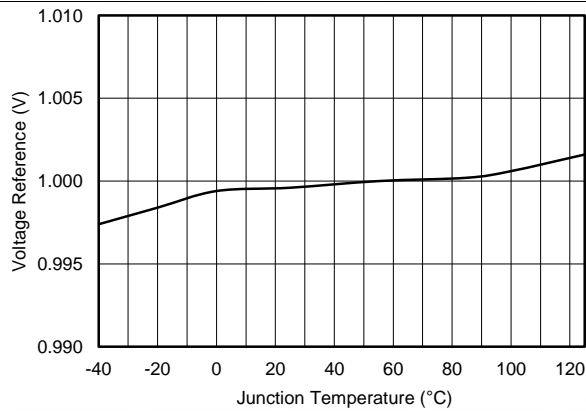

图 5. EN Logic Threshold vs Junction Temperature

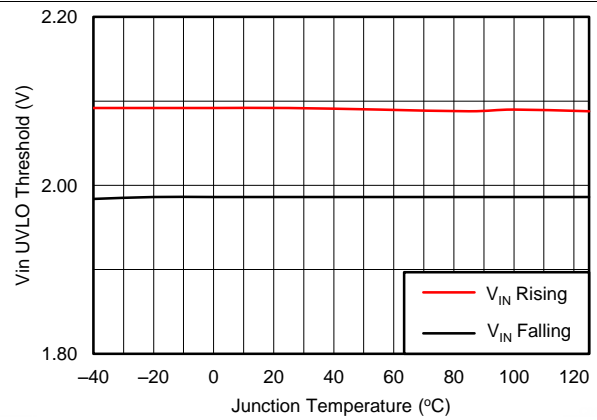

图 6. Quiescent Current vs Input Voltage (Boost Mode)

Typical Characteristics (接下页)

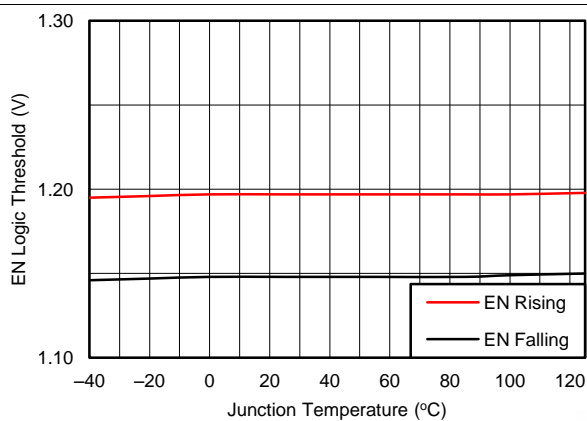
$V_{IN} = 3.6\text{ V}$, $V_{OUT} = 5.0\text{ V}$, $T_J = -40^\circ\text{C}$ to 125°C , unless otherwise noted.

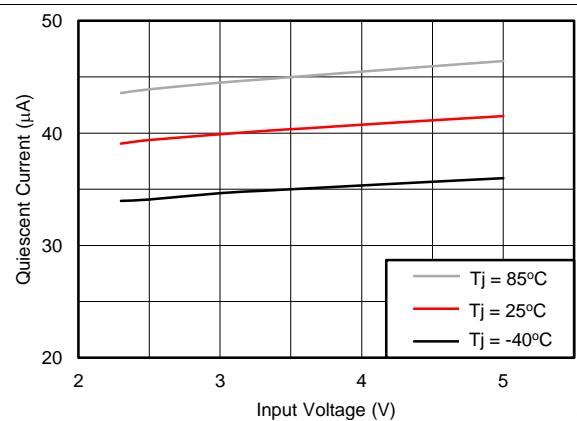

图 7. Shutdown Current vs Input Voltage (Boost Mode)



图 8. Switch Valley Current Limit vs Input Voltage (Boost Mode)

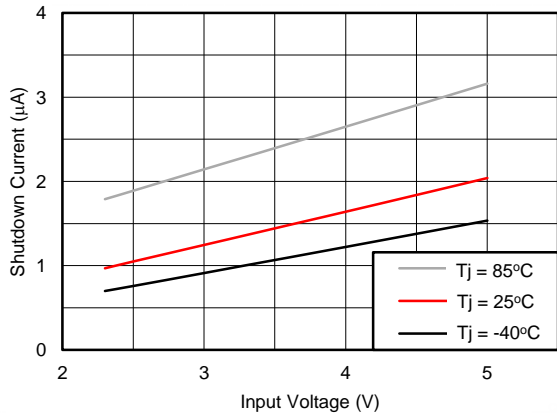

图 9. Soft Start Charge Current vs Junction Temperature

8 Detailed Description

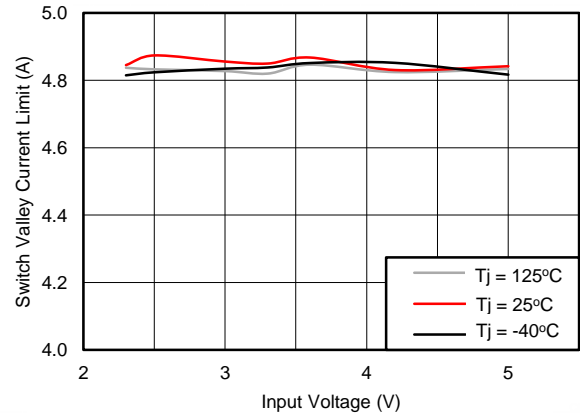
8.1 Overview

The TPS6123x synchronous step-up converter typically operates at a quasi-constant 2-MHz frequency pulse width modulation (PWM) at moderate to heavy load currents. At light load currents, the TPS6123x converter operates in power-save mode with pulse frequency modulation (PFM). The converter uses a novel quasi-constant on-time valley current mode control scheme which provides excellent transient line / load response with minimal output capacitance. Internal loop compensation simplifies the design process while minimizing the number of external components. The TPS6123x device can smoothly transit in and out of zero duty cycle mode (high side FET full on). Therefore the output can be kept as close as possible to its regulation limits even though the converter is subject to an input voltage that tends to be excessive.

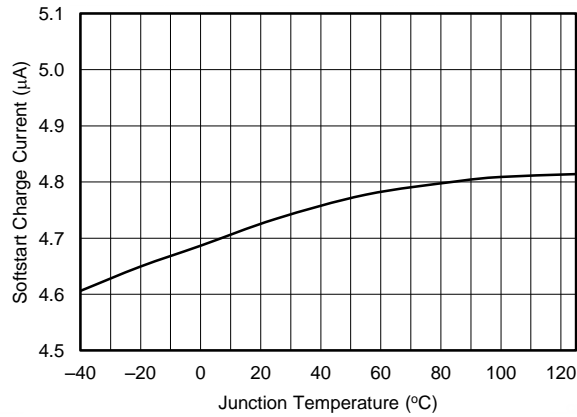
8.2 Functional Block Diagram

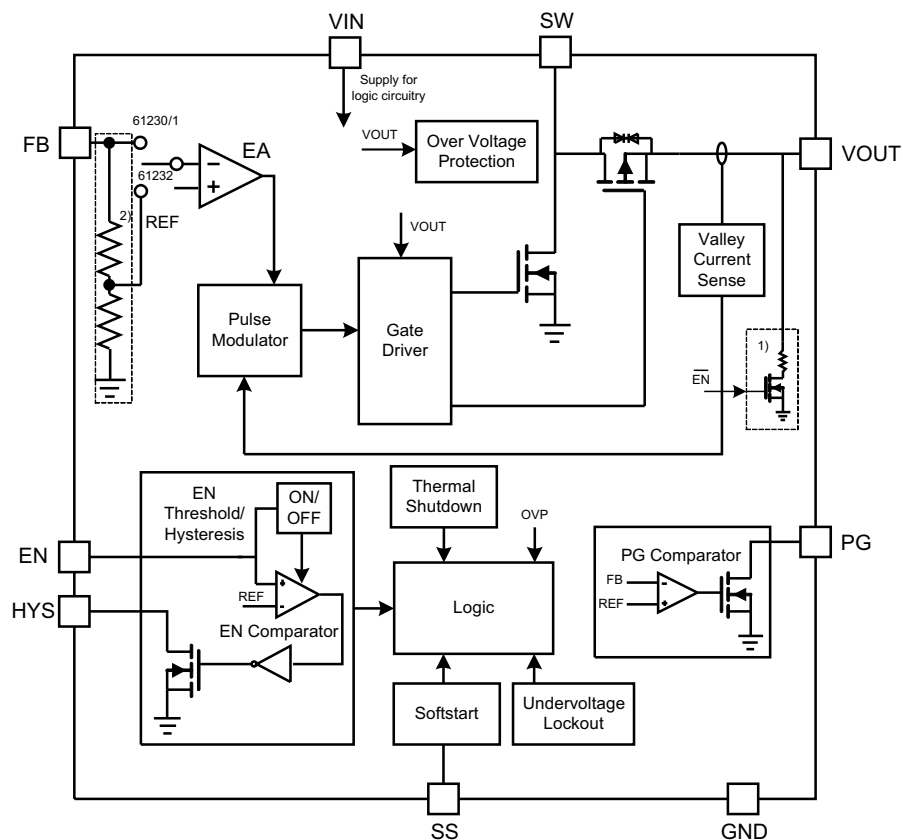

(1) Output discharge block is implemented in TPS61231 only.

(2) Internal resistor divider is implemented in TPS61232 only. For adjustable output versions, the FB pin is directly connected to the negative pin of the EA.

8.3 Feature Description

8.3.1 Startup

In boost mode (PWM or PFM), the rectifying switch is turned on first until the output capacitor is charged to 0.5 V with the current limit of 550 mA after the device is enabled. Then, the output capacitor is continuously charged to a value close to the input voltage. This is called the pre-charge phase. During the pre-charge phase, the output current is limited by the pre-charge current limit of the high side rectifying switch and the SS pin voltage follows the FB voltage (in the TPS61232, the SS pin follows the internal FB voltage). Once the output capacitor has been biased to the input voltage, the device starts switching. This is called the soft start phase. During the soft

Feature Description (接下页)

start phase, the SS pin voltage limits the FB pin voltage, and the output voltage rising slope follows the SS pin voltage slope. The capacitor connected to the SS pin is charged by the internal bias current of I_{SS} , giving the time of the soft start phase shown in 公式 1. The larger the soft start capacitor, the longer the soft start phase time. Leaving the SS pin floating sets the minimum soft startup phase time. The device finishes the soft start phase and operates normally when the nominal output voltage is reached.

$$t_{SS} = \frac{C_{SS}}{5 \mu A} \times \left(1 - \frac{V_{IN}}{V_{OUT}} \right) \times V_{REF} \quad (1)$$

The SS pin voltage is discharged in the cases when the device gets disabled by the EN pin, thermal shutdown and undervoltage lockout. The SS pin may be left floating to disable the soft start phase and start up with the fastest time. In zero duty cycle mode, only the pre-charge phase works during startup.

8.3.2 Current Limit Operation

The device employs a valley current sensing scheme. Switch valley current limit detection occurs during the off time through sensing of the voltage drop across the synchronous rectifier. If the current is above the valley current limit level when it is time to turn off the synchronous rectifier, the device instead keeps the synchronous rectifier on until its current decreases below the valley current limit level. The maximum continuous output current $I_{OUT(MAX)}$, before entering switch valley current limit operation, is defined by 公式 2.

$$I_{OUT(MAX)} = (1-D) \times \left(I_{LIM_SW} + \frac{1}{2} \Delta I_L \right)$$

$$D = \frac{V_{OUT} - V_{IN}}{V_{OUT}}$$

$$\Delta I_L = \frac{V_{IN}}{L} \times \frac{D}{f_{SW}} \quad (2)$$

Where

I_{LIM_SW} = Switch valley current limit

L = Inductor value

f_{SW} = Switching frequency

When the switch current limit is reached, the output voltage decreases from further load increase. The switch valley current limit works in PWM, PFM and Zero Duty Cycle Mode operations.

Another current limit scheme, pre-charge current limit, I_{LIM_Pre} is implemented. Pre-charge current limit detection works when $V_{OUT} < V_{OUT_NOM}$ and $V_{OUT} < V_{IN}$. It can happen when the device is in the pre-charge phase or an over load condition. It impacts the minimum load resistance at startup as shown in 图 14 and 图 27.

8.3.3 Enable/Disable

The EN pin is connected to an ON/OFF detector (ON/OFF) and an input of the Enable Comparator, shown in the functional block diagram. With a voltage level of 0.4 V or less at the EN pin, the ON/OFF detector turns the device into Shutdown mode and the quiescent current is reduced to typically 1.5 μA . In this mode, the EN comparator and the entire internal control circuitry are switched off. A voltage level of typically 0.9 V at the EN pin triggers the ON/OFF detector and activates the internal reference, the EN comparator and the UVLO comparator. Once the ON/OFF detector has tripped, the quiescent current into the VIN pin is typically 1.5 μA .

The TPS6123x starts regulation once the voltage at the EN pin trips the threshold $V_{EN_TH_ON}$ and the VIN pin voltage is above the UVLO threshold. The device enters startup and ramps up the output voltage. The TPS6123x stops regulation once the voltage on the EN pin falls below the threshold $V_{EN_TH_OFF}$ or the VIN pin voltage falls below the UVLO threshold. For proper operation, The EN pin must be terminated and must not be left floating. An external logic signal applied directly to the EN pin can enable/disable the device. The device can be driven into shutdown mode by pulling the EN pin to GND. In this mode, true load disconnect between the battery and load prevents current flow from V_{IN} to V_{OUT} , as well as reverse flow from V_{OUT} to V_{IN} .

Feature Description (接下页)

8.3.4 Undervoltage Lockout

An under voltage lockout is implemented to avoid mis-operation of the device at low input voltages. It shuts down the device with voltages lower than V_{UVLO} .

Use the HYS pin to configure a new undervoltage lockout threshold and hysteresis shown in 图 10 and 公式 3. The new thresholds must be higher than V_{UVLO} ; otherwise it does not work. The device holds the HYS pin low until the EN voltage rises above $V_{EN_TH_ON}$. Then, the HYS pin goes high impedance.



图 10. EN Comparator threshold and hysteresis setting

$$\begin{aligned}
 V_{IN_OFF} &= V_{TH_EN_OFF} \times \left(1 + \frac{REN1}{REN2 + REN3}\right) = 1.14V \times \left(1 + \frac{REN1}{REN2 + REN3}\right) \\
 V_{IN_ON} &= V_{TH_EN_ON} \times \left(1 + \frac{REN1}{REN2}\right) = 1.19V \times \left(1 + \frac{REN1}{REN2}\right)
 \end{aligned}
 \tag{3}$$

8.3.5 Output Capacitor Discharge, TPS61231

To make sure the device starts up under defined conditions, the output capacitor of the TPS61231 gets discharged by the VOUT pin with a typical discharge resistor of R_{DIS} in the cases when the device gets disabled by the EN pin, thermal shutdown, and undervoltage lockout.

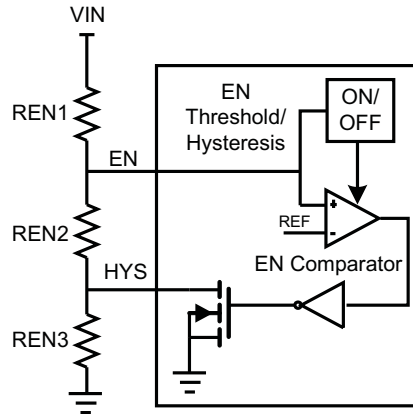
8.3.6 Power Good Output

The PG output is low when the output voltage is below 90% of its nominal value. The PG pin becomes high impedance once the output is higher than 95% of its nominal voltage. The PG pin is an open drain output and is specified to sink up to 500 μA . This PG output requires a pull-up resistor that cannot be connected to any voltage higher than 5.5 V. PG is held low when the device is disabled by the EN pin and thermal shutdown.

8.3.7 Over Voltage Protection

The device stops switching as soon as the output voltage exceeds V_{OVP} . When the output voltage falls 0.15V below the OVP threshold, the device resumes normal operation until the output voltage exceeds the OVP threshold again.

8.3.8 Thermal Shutdown

The device goes into thermal shutdown and stops switching once the junction temperature exceeds T_{JSD} . Once the junction temperature falls below the threshold, it returns to normal operation automatically.

8.4 Device Functional Modes

The TPS6123x boost converter family has three operation modes, as shown in 表 1.

表 1. Operation Mode Description

MODE	DESCRIPTION	CONDITION
PWM	Boost in normal switching operation	$V_{IN} < V_{OUT} + 0.2 \text{ V}$, heavy load
PFM	Boost in power save operation	$V_{IN} < V_{OUT} + 0.2 \text{ V}$, light load
Zero Duty Cycle	Zero duty cycle operation	$V_{OUT} < V_{IN} \leq V_{OUT} + 0.24 \text{ V}$ and $V_{OUT} \geq V_{OUT_NOM}$

8.4.1 Boost Normal Mode

The TPS6123x boost converter family typically operates at a quasi-constant 2-MHz frequency pulse width modulation (PWM) at moderate to heavy load currents. Based on the V_{IN}/V_{OUT} ratio, a simple circuit predicts the required on-time. At the beginning of the switching cycle, the low-side N-MOS switch, shown in the functional block diagram, is turned on and the inductor current ramps up to a peak current that is defined by the on-time and the inductance. In the second phase, once this peak current is reached, the current comparator trips, the on-timer is reset turning off the low-side N-MOS switch and turning on the high-side rectifying switch. The current through the inductor then decays to an internally set valley current. Once this occurs, the on-timer is set to turn the boost switch back on again and the cycle is repeated.

8.4.2 Boost Power Save Mode

The device integrates a power save mode with pulse frequency modulation (PFM) to improve efficiency at light load. In power save mode, the device only switches when the output voltage trips below a set threshold voltage. It ramps up the output with several pulses and enters the power save mode when the output voltage exceeds the set threshold voltage. PFM is left and PWM mode entered when the inductor current becomes discontinuous. The DC output voltage in PFM mode rises above the nominal output voltage in PWM mode by 0.7%.



图 11. Output Voltage in PFM/PWM Mode

8.4.3 Zero Duty Cycle Mode

When the input voltage is lower than $V_{OUT} + 0.24 \text{ V}$ and V_{OUT} is higher than the nominal output voltage, the device automatically changes to a Zero Duty Cycle Mode. In Zero Duty Cycle Mode, the rectifying switch is constantly turned on and the low side switch is turned off. The output voltage in this mode depends on the resistance between the input and the output, calculated as:

$$V_{OUT} = V_{IN} - I_{OUT} \times (R_{DS(on)} + R_L) \quad (4)$$

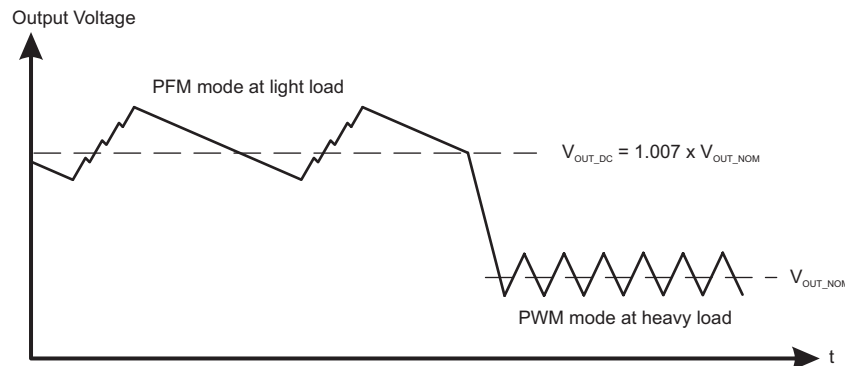
9 Applications and Implementation

注

Information in the following applications sections is not part of the TI component specification, and TI does not warrant its accuracy or completeness. TI's customers are responsible for determining suitability of components for their purposes. Customers should validate and test their design implementation to confirm system functionality.

9.1 Application Information

The devices are designed to operate from an input voltage supply range between 2.3 V and 5.5 V with a maximum output current of 2.1 A. The devices operate in PWM mode for medium to heavy load conditions and in power save mode at light load currents. In PWM mode the TPS6123x converter operates with the nominal switching frequency of 2 MHz which provides a controlled frequency variation over the input voltage range. As the load current decreases, the converter enters power save mode, reducing the switching frequency and minimizing the IC quiescent current to achieve high efficiency over the entire load current range. The WEBENCH software uses an iterative design procedure and accesses a comprehensive database of components when generating a design. See the [相关文档](#) section for additional documentation.

9.2 Typical Applications

9.2.1 TPS61230 2.3-V to 5.5-V Input, 5-V Output Converter



图 12. TPS61230 5-V Output Typical Application

9.2.1.1 TPS61230 5-V Output Design Requirements

Use the following typical application design procedure to select external components values for the TPS61230 device.

表 2. TPS61230 5-V Output Design Parameters

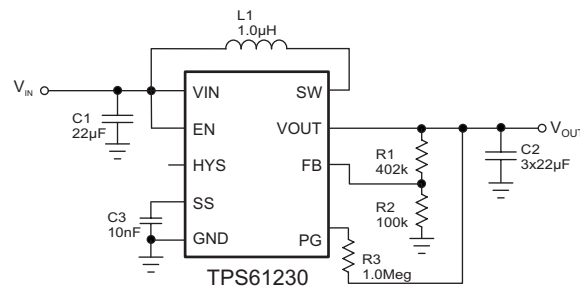
DESIGN PARAMETERS	EXAMPLE VALUES
Input Voltage Range	2.3 V to 5.5 V
Output Voltage	5.0 V
Output Voltage Ripple	±3% V_{OUT}
Transient Response	±10% V_{OUT}
Input Voltage Ripple	±200 mV
Output Current Rating	2.1 A
Operating Frequency	2 MHz

9.2.1.2 TPS61230 5-V Detailed Design Procedure

表 3. TPS61230 5-V Output List of Components

REFERENCE	DESCRIPTION	MANUFACTURER
L1	1.0 μH, power inductor, XFL4020-102MEB	Coilcraft
C1	2 μF 6.3 V, 0805, X5R ceramic, GRM21BR60J226ME39	Murata
C2	3 × 22 μF 10 V, 0805, X5R ceramic, LMK212BBJ226MG	YUDEN
C3	10 nF, X7R ceramic	Murata
R1	402 k, resistor, chip, 1/10W, 1%	Rohm
R2	100 k, resistor, chip, 1/10W, 1%	Rohm

9.2.1.2.1 Programming the Output Voltage

The TPS6123x device family's output voltage need to be programmed via an external voltage divider to set the desired output voltage.

An external resistor divider is used, as shown in 公式 5. By selecting R1 and R2, the output voltage is programmed to the desired value. When the output voltage is regulated, the typical voltage at the FB pin is V_{FB} . The following equation can be used to calculate R1 and R2.

$$V_{OUT} = V_{FB} \times \left(1 + \frac{R1}{R2}\right) = 1V \times \left(1 + \frac{R1}{R2}\right) \quad (5)$$

For best accuracy, R2 should be kept smaller than 100 kΩ to ensure that the current following through R2 is at least 100 times larger than FB pin leakage current. Changing R2 towards a lower value increases the robustness against noise injection. Changing the R2 towards higher values reduces the quiescent current for achieving highest efficiency at low load currents.

For the fixed output voltage version, TPS61232, the FB pin must be tied to the output directly.

9.2.1.2.2 Inductor and Capacitor Selection

The second step is the selection of the inductor and capacitor components. To simplify this process, 表 4 outlines possible inductor and output capacitor value combinations.

表 4. Inductor and Output Capacitor Combinations

L (μH) ⁽¹⁾	C _{OUT} (μF) ⁽²⁾			
	10	20	47	100
0.47		√	√	√
1.0		√ ⁽³⁾	√	√
1.5				

(1) This is the nominal inductance of inductor. Inductor tolerance and current de-rating is anticipated. The effective inductance can vary by -30%.

(2) This is the effective capacitance of output capacitors. A higher nominal value is required.

(3) Typical application configuration. Other check mark indicates alternative filter combinations.

9.2.1.2.2.1 Inductor Selection

A boost converter requires two main passive components for storing energy during the conversion, an inductor and an output capacitor. It is advisable to select an inductor with a saturation current rating higher than the possible peak current flowing through the power switches. The inductor peak current varies as a function of the load, the input and output voltages and is estimated using 公式 6.

$$I_{L(PEAK)} = \frac{I_{OUT}}{(1-D) \times \eta} + \frac{1}{2} \times \frac{V_{IN} \times D}{L \times f_{SW}} \quad (6)$$

Where

η = Power conversion estimated efficiency

Selecting an inductor with insufficient saturation performance can lead to excessive peak current in the converter. This could eventually harm the device and reduce reliability. It's recommended to choose the saturation current for the inductor 20%–30% higher than the $I_{L(PEAK)}$, from 公式 6. The following inductors are recommended to be used in designs.

表 5. List of Inductors

INDUCTANCE [μH]	CURRENT RATING [A]	DC RESISTANCE [mΩ]	PART NUMBER	MANUFACTURER
1.0	5.4	10.8	XFL4020-102ME	Coilcraft
1.0	7.5	9	LQH6PPN1R0	muRata
0.47	6.6	7.6	XFL4015-471ME	Coilcraft

9.2.1.2.2.2 Output Capacitor Selection

For the output capacitor, it is recommended to use small X5R or X7R ceramic capacitors placed as close as possible to the V_{OUT} and GND pins of the IC. If, for any reason, the application requires the use of large capacitors which cannot be placed close to the IC, using a smaller ceramic capacitor of 1 μF in parallel to the large one is highly recommended. This small capacitor should be placed as close as possible to the V_{OUT} and GND pins of the IC.

Care must be taken when evaluating a capacitor's derating under bias. The bias can significantly reduce capacitance. Ceramic capacitors can lose as much as 50% of their capacitance at rated voltage. Therefore, leave margin on the voltage rating to ensure adequate effective capacitance.

The ESR impact on the output ripple must be considered as well, if tantalum or electrolytic capacitors are used. Assuming there is enough capacitance such that the ripple due to the capacitance can be ignored, the ESR needed to limit the V_{Ripple} is:

$$V_{Ripple(ESR)} = I_{L(PEAK)} \times ESR \quad (7)$$

9.2.1.2.2.3 Input Capacitor Selection

Multilayer X5R or X7R ceramic capacitors are an excellent choice for input decoupling of the step-up converter as they have extremely low ESR and are available in small footprints. Input capacitors should be located as close as possible to the device. While a 22-μF input capacitor is sufficient for most applications, larger values may be used to reduce input current ripple without limitations. Take care when using only ceramic input capacitors. When a ceramic capacitor is used at the input and the power is being supplied through long wires, such as from a wall adapter, a load step at the output can induce ringing at the VIN pin. This ringing can couple to the output and be mistaken as loop instability or could even damage the part. Additional "bulk" capacitance (electrolytic or tantalum) should in this circumstance be placed between C_{IN} and the power source to reduce ringing than can occur between the inductance of the power source leads and C_{IN}.

9.2.1.2.3 Loop Stability, Feed Forward Capacitor

The third step is to check the loop stability. The stability evaluation is to look from a steady-state perspective at the following signals:

- Switching node, SW
- Inductor current, I_L
- Output ripple, $V_{Ripple(OUT)}$

When the switching waveform shows large duty cycle jitter or the output voltage or inductor current shows oscillations, the regulation loop may be unstable. This is often a result of board layout and/or L-C combination.

The load transient response is another approach to check the loop stability. During the load transient recovery time, V_{OUT} can be monitored for settling time, overshoot or ringing that helps judge the converter's stability. Without any ringing, the loop has usually more than 45° of phase margin.

As for the heavy load transient applications such as a 2 A load step transient, a feed forward capacitor in parallel with R1 is recommended. The feed forward capacitor increases the loop bandwidth by adding a zero. This results in a lower output voltage drop, as shown in 图 36. Set the feed forward capacitor zero near 20 kHz for most applications. See application report *Optimizing Transient Response of Internally Compensated dc-dc Converters With Feedforward Capacitor* (SLVA289).

9.2.1.3 TPS61230 5-V Output Application Performance Plots

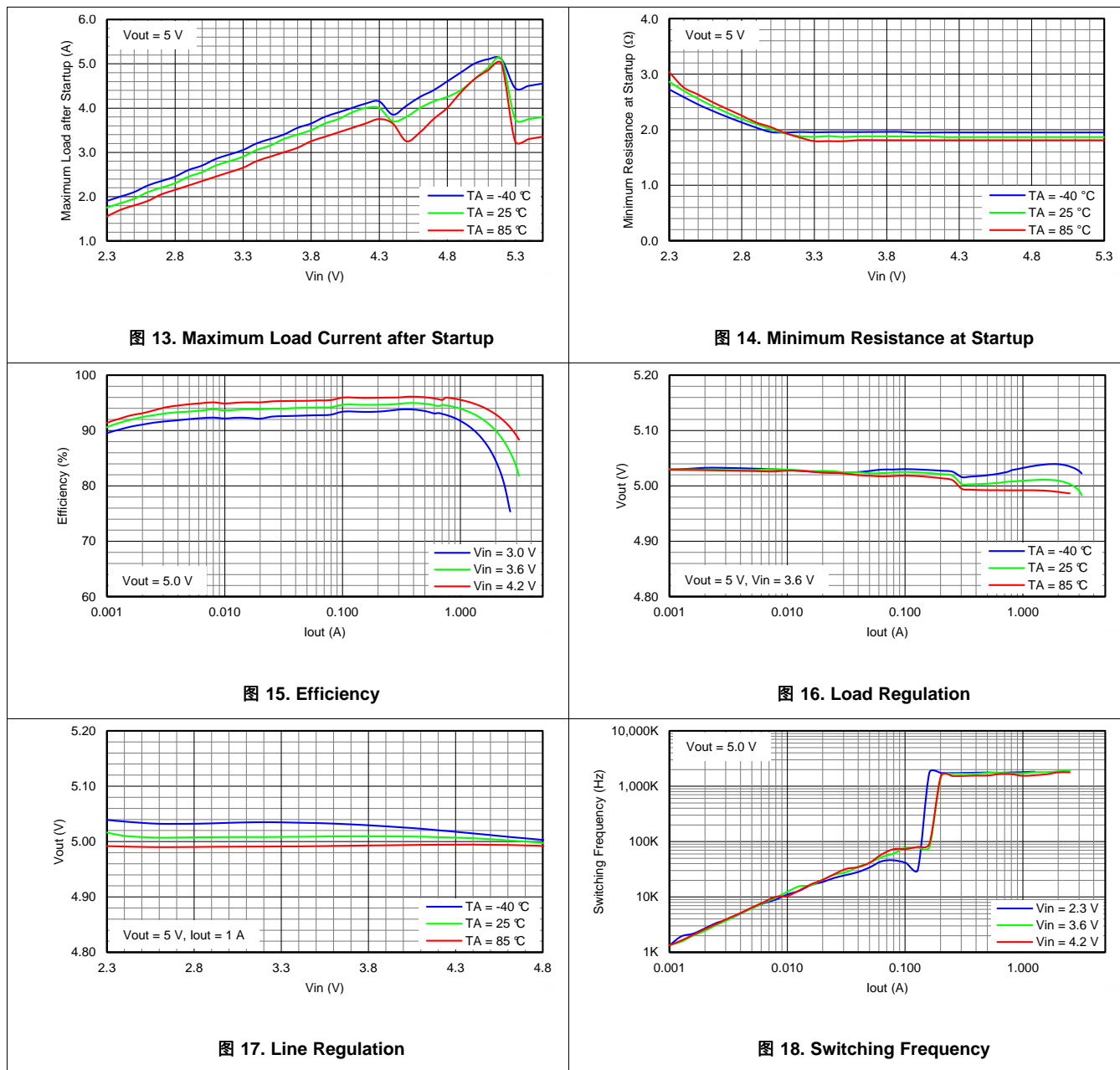



图 19. PWM Operation ($V_{OUT} = 5\text{ V}$, $I_{OUT} = 2\text{ A}$)



图 20. PFM Operation ($V_{OUT} = 5\text{ V}$, $I_{OUT} = 50\text{ mA}$)

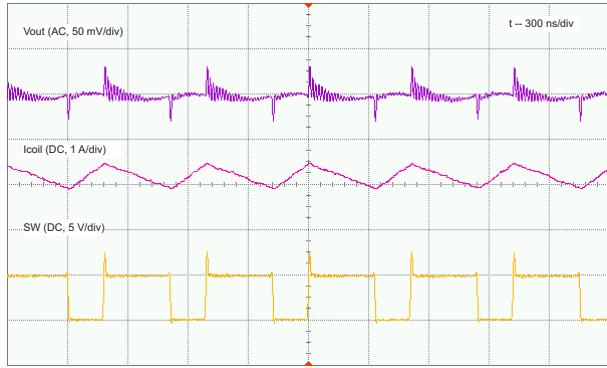

图 21. Load Transient ($V_{OUT} = 5\text{ V}$, $I_{OUT} = 0.5\text{ A to } 2\text{ A}$)

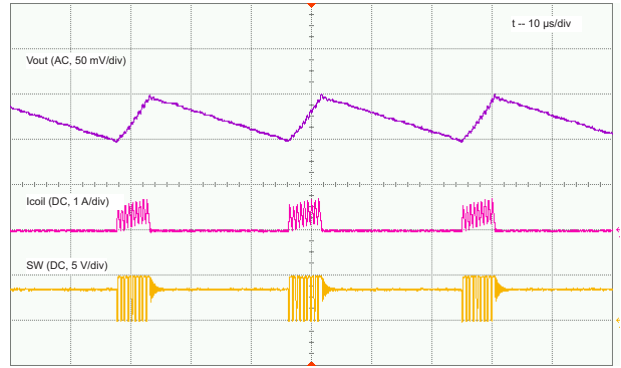

图 22. Output Over Voltage Protection ($FB = 0\text{ V}$, $R_{OUT} = 30\ \Omega$)

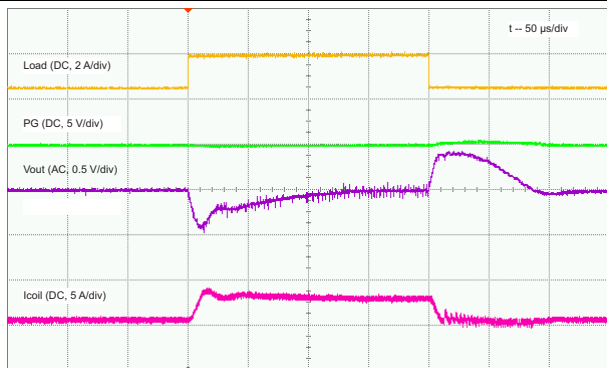

图 23. Startup ($V_{OUT} = 5\text{ V}$, $R_{OUT} = 2.5\ \Omega$)

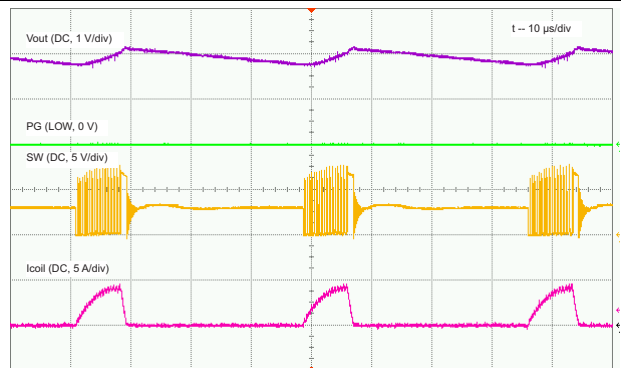

图 24. Shutdown ($V_{OUT} = 5\text{ V}$, $R_{OUT} = 2.5\ \Omega$)

9.2.2 TPS61230 2.3-V to 5.5-V Input, 3.5-V Output Converter

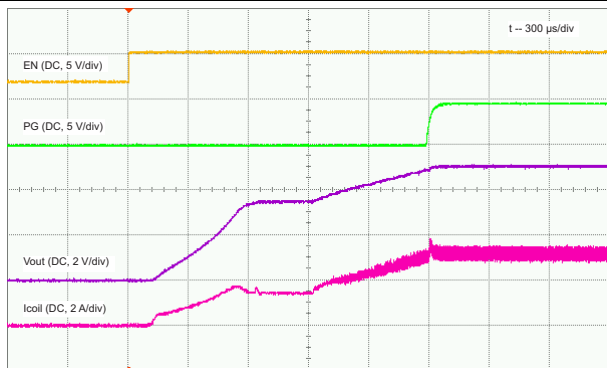

图 25. TPS61230 3.5-V Output Typical Application

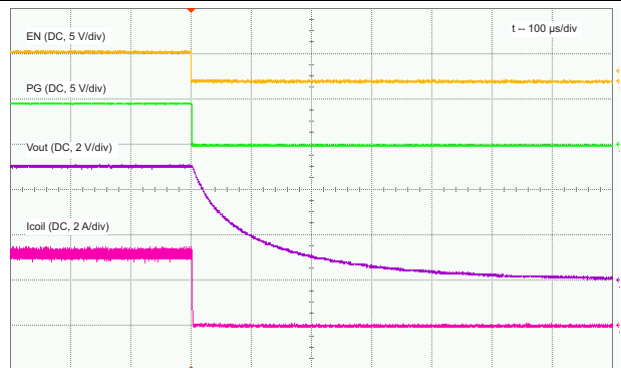
9.2.2.1 TPS61230 3.5-V Output Design Requirements

表 6. TPS61230 3.5-V Output Design Parameters

DESIGN PARAMETERS	EXAMPLE VALUES
Input Voltage Range	2.3 V to 5.5 V
Output Voltage	3.5 V
Output Voltage Ripple	±3% V _{OUT}
Transient Response	±10% V _{OUT}
Input Voltage Ripple	±200 mV
Output Current Rating	2.1 A
Operating Frequency	2 MHz

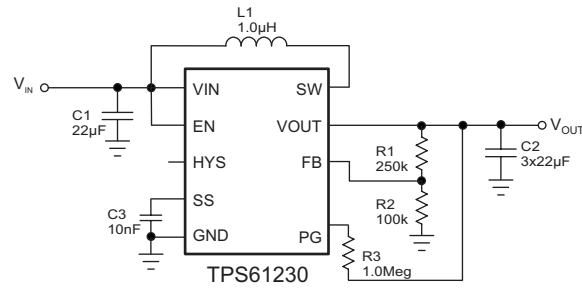
9.2.2.2 Detailed Design Procedure

Refer to the [TPS61230 5-V Detailed Design Procedure](#) section for the 3.5-V detailed design procedures.

9.2.2.3 TPS61230 3.5-V Output Application Performance Plots

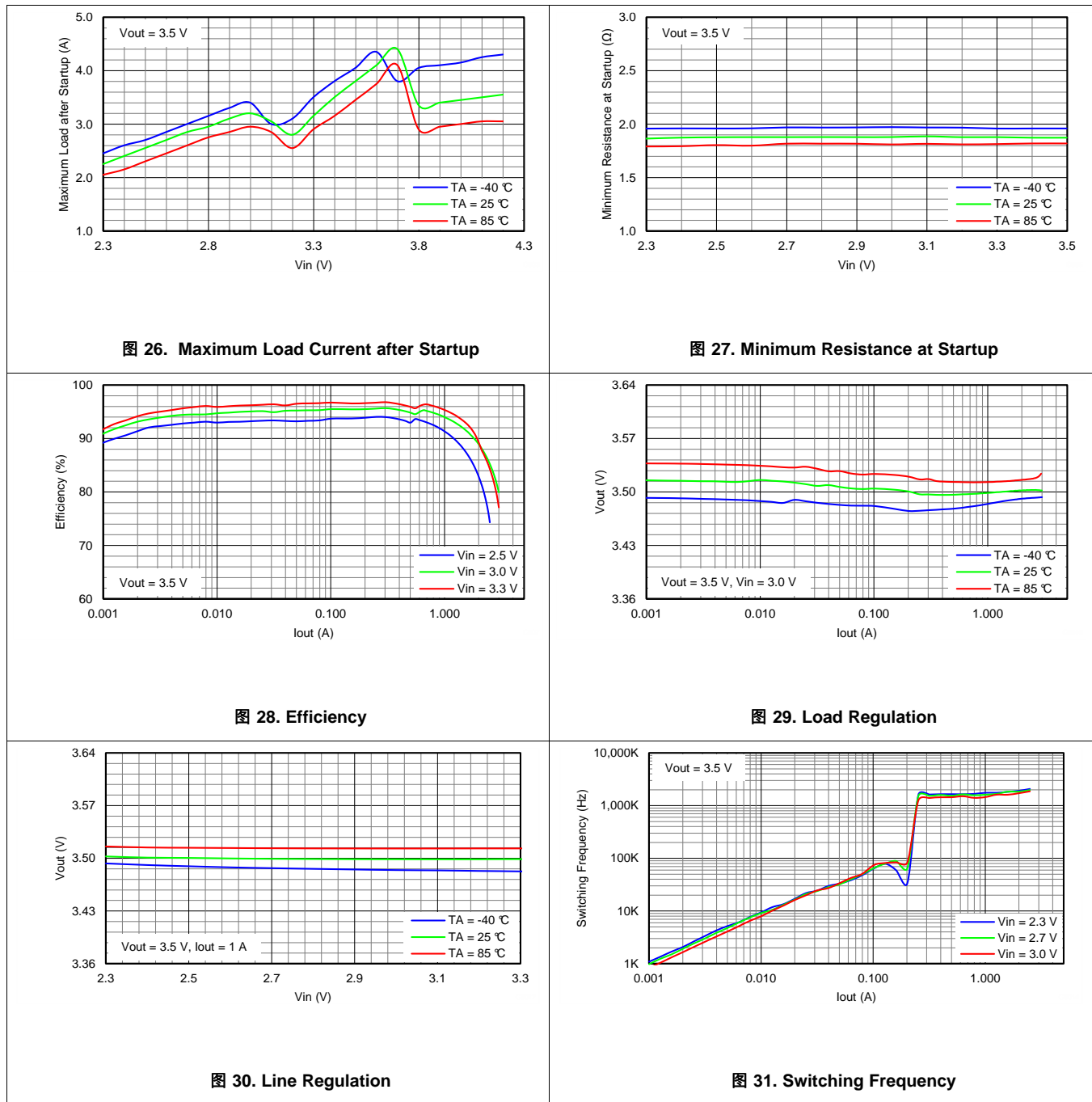



图 32. Input Sweep ($V_{OUT} = 3.5\text{ V}$, $V_{IN} = 2.7\text{ V}$ to 4.2 V , $I_{OUT} = 1.5\text{ A}$)



图 33. Startup ($V_{OUT} = 3.5\text{ V}$, $V_{IN} = 3.0\text{ V}$, $R_{OUT} = 2.3\ \Omega$)

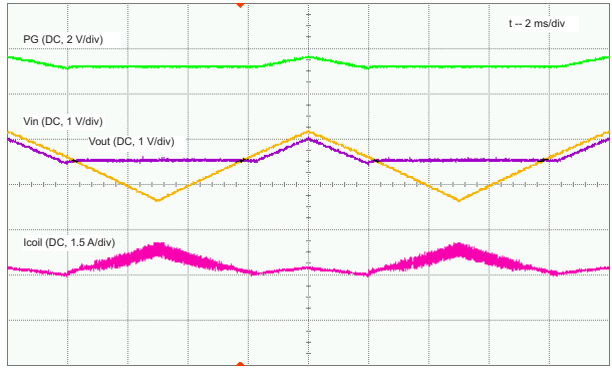

图 34. Shutdown ($V_{OUT} = 3.5\text{ V}$, $V_{IN} = 3.0\text{ V}$, $R_{OUT} = 2.3\ \Omega$)

9.2.3 TPS61230 Application with Feed Forward Capacitor for Best Transient Response

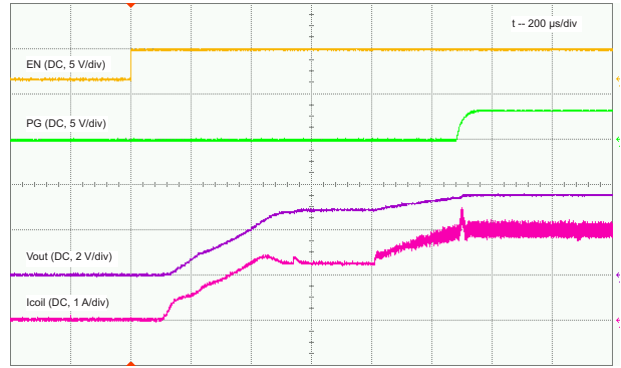
As for the heavy load transient applications such as a 2-A load step transient, a feed forward capacitor in parallel with R1 is recommended. The feed forward capacitor increases the loop bandwidth by adding a zero. This results in a lower output voltage drop, as shown in [图 36](#). Set the feed forward capacitor zero near 20 kHz for most applications. See application report *Optimizing Transient Response of Internally Compensated dc-dc Converters With Feedforward Capacitor* (SLVA289).

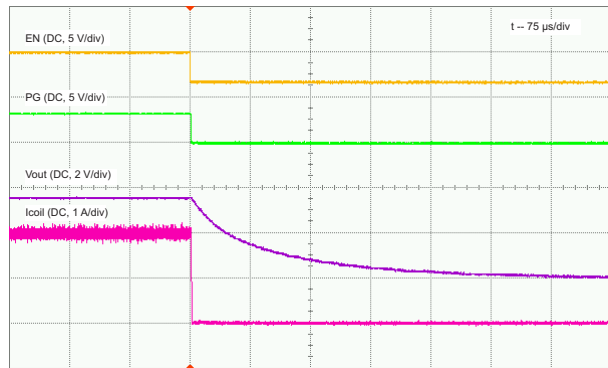

图 35. TPS61230 5-V Output with Cff Typical Application

9.2.3.1 Design Requirements

Refer to the [TPS61230 5-V Output Design Requirements](#) section for the design requirements.

9.2.3.2 Detailed Design Procedure

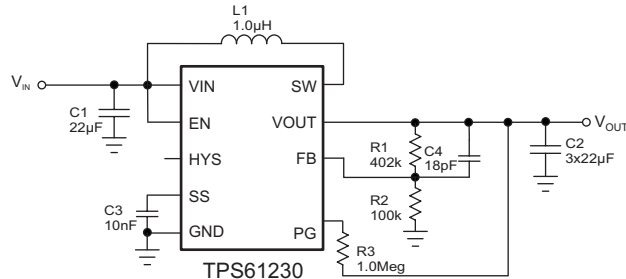
Refer to the [TPS61230 5-V Detailed Design Procedure](#) section for the detailed design procedures.

9.2.3.3 Application Curve



图 36. Load Transient ($V_{OUT} = 5\text{ V}$, $I_{OUT} = 0.5\text{ A to } 2\text{ A}$, $C_{FF} = 18\text{ pF}$)

10 Power Supply Recommendations

The device is designed to operate from an input voltage supply range between 2.3 V and 5.5 V. This input supply must be well regulated. If the input supply is located more than a few inches from the converter, additional bulk capacitance may be required in addition to the ceramic bypass capacitors. An electrolytic or tantalum capacitor with a value of 47 μF is a typical choice.

11 Layout

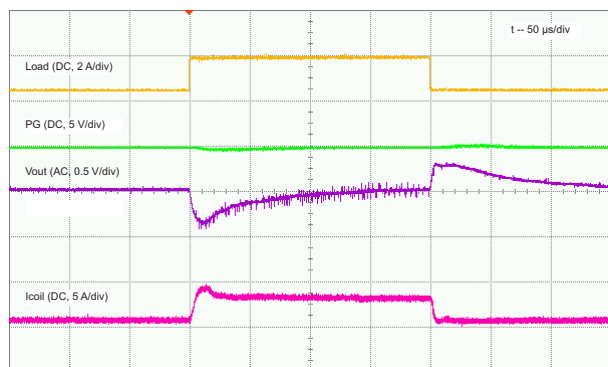
11.1 Layout Guidelines

For all switching power supplies, the layout is an important step in the design, especially at high peak currents and high switching frequencies. If the layout is not carefully done, the regulator could show stability problems as well as EMI problems. Therefore, use wide and short traces for the main current path and for the power ground tracks. The input capacitor, output capacitor, and the inductor should be placed as close as possible to the IC. Use a common ground node for power ground and a different one for control ground to minimize the effects of ground noise. Connect these ground nodes at the GND pin of the IC. The most critical current path for all boost converters is from the switching FET, through the synchronous FET, then the output capacitors, and back to ground of the switching FET. Therefore, the output capacitors and their traces should be placed on the same board layer as the IC and as close as possible between the IC's VOUT and GND pin.

See [Figure 37](#) for the recommended layout.

11.2 Layout Example



图 37. Layout Recommendation

11.3 Thermal Considerations

Implementation of integrated circuits in low-profile and fine-pitch surface-mount packages typically requires special attention to power dissipation. Many system-dependent issues such as thermal coupling, airflow, added heat sinks and convection surfaces, and the presence of other heat-generating components affect the power-dissipation limits of a given component.

Two basic approaches for enhancing thermal performance are listed below.

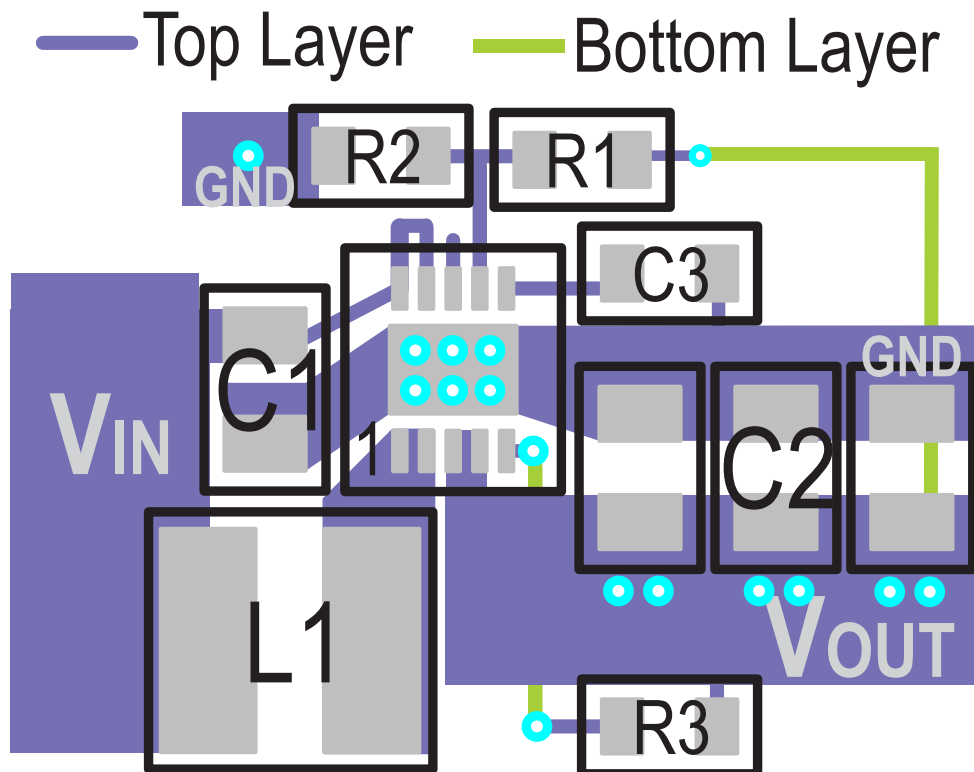
- Improving the power dissipation capability of the PCB design
- Introducing airflow in the system

Thermal Considerations (接下页)

For more details on how to use the thermal parameters in the dissipation ratings table please check the application report *Thermal Characteristics of Linear and Logic Packages Using JEDEC PCB Designs* ([SZZA017](#)) and the application report *Semiconductor and IC Package Thermal Metrics* ([SPRA953](#)).

12 器件和文档支持

12.1 器件支持

12.1.1 第三方产品免责声明

TI 发布的与第三方产品或服务有关的信息，不能构成与此类产品或服务或保修的适用性有关的认可，不能构成此类产品或服务单独或与任何 TI 产品或服务一起的表示或认可。

12.2 文档支持

12.2.1 相关文档

《采用前馈电容优化内部补偿 DC-DC 转换器的瞬态响应》 [SLVA289](#)

《采用 JEDEC PCB 设计的线性和逻辑封装散热特性》 ([SZZA017](#))

《半导体和 IC 封装热指标》 ([SPRA953](#))

12.3 相关链接

以下表格列出了快速访问链接。范围包括技术文档、支持与社区资源、工具和软件，并且可以快速访问样片或购买链接。

表 7. 相关链接

部件	产品文件夹	样片与购买	技术文档	工具与软件	支持与社区
TPS61230	请单击此处	请单击此处	请单击此处	请单击此处	请单击此处
TPS61231	请单击此处	请单击此处	请单击此处	请单击此处	请单击此处
TPS61232	请单击此处	请单击此处	请单击此处	请单击此处	请单击此处

12.4 商标

All trademarks are the property of their respective owners.

12.5 静电放电警告



这些装置包含有限的内置 ESD 保护。存储或装卸时，应将导线一起截短或将装置放置于导电泡棉中，以防止 MOS 门极遭受静电损伤。

12.6 术语表

[SLYZ022](#) — TI 术语表。

这份术语表列出并解释术语、首字母缩略词和定义。

13 机械封装和可订购信息

以下页中包括机械封装和可订购信息。 这些信息是针对指定器件可提供的最新数据。 这些数据会在无通知且不对本文档进行修订的情况下发生改变。 欲获得该数据表的浏览器版本，请查阅左侧的导航栏。

重要声明

德州仪器(TI)及其下属子公司有权根据 JESD46 最新标准,对所提供的产品和服务进行更正、修改、增强、改进或其它更改,并有权根据 JESD48 最新标准中止提供任何产品和服务。客户在下订单前应获取最新的相关信息,并验证这些信息是否完整且是最新的。所有产品的销售都遵循在订单确认时所提供的TI 销售条款与条件。

TI 保证其所销售的组件的性能符合产品销售时 TI 半导体产品销售条件与条款的适用规范。仅在 TI 保证的范围内,且 TI 认为有必要时才会使用测试或其它质量控制技术。除非适用法律做出了硬性规定,否则没有必要对每种组件的所有参数进行测试。

TI 对应用帮助或客户产品设计不承担任何义务。客户应对其使用 TI 组件的产品和应用自行负责。为尽量减小与客户产品和应用相关的风险,客户应提供充分的设计与操作安全措施。

TI 不对任何 TI 专利权、版权、屏蔽作品权或其它与使用了 TI 组件或服务的组合设备、机器或流程相关的 TI 知识产权中授予的直接或隐含权限作出任何保证或解释。TI 所发布的与第三方产品或服务有关的信息,不能构成从 TI 获得使用这些产品或服务的许可、授权、或认可。使用此类信息可能需要获得第三方的专利权或其它知识产权方面的许可,或是 TI 的专利权或其它知识产权方面的许可。

对于 TI 的产品手册或数据表中 TI 信息的重要部分,仅在没有对内容进行任何篡改且带有相关授权、条件、限制和声明的情况下才允许进行复制。TI 对此类篡改过的文件不承担任何责任或义务。复制第三方的信息可能需要服从额外的限制条件。

在转售 TI 组件或服务时,如果对该组件或服务参数的陈述与 TI 标明的参数相比存在差异或虚假成分,则会失去相关 TI 组件或服务的所有明示或暗示授权,且这是不正当的、欺诈性商业行为。TI 对任何此类虚假陈述均不承担任何责任或义务。

客户认可并同意,尽管任何应用相关信息或支持仍可能由 TI 提供,但他们将独立负责满足与其产品及其在应用中使用的 TI 产品相关的所有法律、法规和安全相关要求。客户声明并同意,他们具备制定与实施安全措施所需的全部专业技术和知识,可预见故障的危险后果、监测故障及其后果、降低有可能造成人身伤害的故障的发生机率并采取适当的补救措施。客户将全额赔偿因在此类安全关键应用中使用任何 TI 组件而对 TI 及其代理造成的任何损失。

在某些场合中,为了推进安全相关应用有可能对 TI 组件进行特别的促销。TI 的目标是利用此类组件帮助客户设计和创立其特有的可满足适用的功能安全性标准和要求的终端产品解决方案。尽管如此,此类组件仍然服从这些条款。

TI 组件未获得用于 FDA Class III (或类似的生命攸关医疗设备)的授权许可,除非各方授权官员已经达成了专门管控此类使用的特别协议。

只有那些 TI 特别注明属于军用等级或“增强型塑料”的 TI 组件才是设计或专门用于军事/航空应用或环境的。购买者认可并同意,对并非指定面向军事或航空航天用途的 TI 组件进行军事或航空航天方面的应用,其风险由客户单独承担,并且由客户独立负责满足与此类使用相关的所有法律和法规要求。

TI 已明确指定符合 ISO/TS16949 要求的产品,这些产品主要用于汽车。在任何情况下,因使用非指定产品而无法达到 ISO/TS16949 要求, TI 不承担任何责任。

	产品		应用
数字音频	www.ti.com.cn/audio	通信与电信	www.ti.com.cn/telecom
放大器和线性器件	www.ti.com.cn/amplifiers	计算机及周边	www.ti.com.cn/computer
数据转换器	www.ti.com.cn/dataconverters	消费电子	www.ti.com.cn/consumer-apps
DLP® 产品	www.dlp.com	能源	www.ti.com.cn/energy
DSP - 数字信号处理器	www.ti.com.cn/dsp	工业应用	www.ti.com.cn/industrial
时钟和计时器	www.ti.com.cn/clockandtimers	医疗电子	www.ti.com.cn/medical
接口	www.ti.com.cn/interface	安防应用	www.ti.com.cn/security
逻辑	www.ti.com.cn/logic	汽车电子	www.ti.com.cn/automotive
电源管理	www.ti.com.cn/power	视频和影像	www.ti.com.cn/video
微控制器 (MCU)	www.ti.com.cn/microcontrollers		
RFID 系统	www.ti.com.cn/rfidsys		
OMAP应用处理器	www.ti.com/omap		
无线连通性	www.ti.com.cn/wirelessconnectivity	德州仪器在线技术支持社区	www.deyisupport.com

邮寄地址: 上海市浦东新区世纪大道1568号, 中建大厦32楼邮政编码: 200122
Copyright © 2014, 德州仪器半导体技术(上海)有限公司

PACKAGING INFORMATION

Orderable Device	Status (1)	Package Type	Package Drawing	Pins	Package Qty	Eco Plan (2)	Lead finish/ Ball material (6)	MSL Peak Temp (3)	Op Temp (°C)	Device Marking (4/5)	Samples
TPS61230DRCR	ACTIVE	VSON	DRC	10	3000	RoHS & Green	NIPDAU	Level-2-260C-1 YEAR	-40 to 85	SBK	Samples
TPS61230DRCT	ACTIVE	VSON	DRC	10	250	RoHS & Green	NIPDAU	Level-2-260C-1 YEAR	-40 to 85	SBK	Samples
TPS61232DRCR	ACTIVE	VSON	DRC	10	3000	RoHS & Green	NIPDAU	Level-2-260C-1 YEAR	-40 to 85	SBL	Samples
TPS61232DRCT	ACTIVE	VSON	DRC	10	250	RoHS & Green	NIPDAU	Level-2-260C-1 YEAR	-40 to 85	SBL	Samples

(1) The marketing status values are defined as follows:

ACTIVE: Product device recommended for new designs.

LIFEBUY: TI has announced that the device will be discontinued, and a lifetime-buy period is in effect.

NRND: Not recommended for new designs. Device is in production to support existing customers, but TI does not recommend using this part in a new design.

PREVIEW: Device has been announced but is not in production. Samples may or may not be available.

OBSELETE: TI has discontinued the production of the device.

(2) **RoHS:** TI defines "RoHS" to mean semiconductor products that are compliant with the current EU RoHS requirements for all 10 RoHS substances, including the requirement that RoHS substance do not exceed 0.1% by weight in homogeneous materials. Where designed to be soldered at high temperatures, "RoHS" products are suitable for use in specified lead-free processes. TI may reference these types of products as "Pb-Free".

RoHS Exempt: TI defines "RoHS Exempt" to mean products that contain lead but are compliant with EU RoHS pursuant to a specific EU RoHS exemption.

Green: TI defines "Green" to mean the content of Chlorine (Cl) and Bromine (Br) based flame retardants meet JS709B low halogen requirements of <=1000ppm threshold. Antimony trioxide based flame retardants must also meet the <=1000ppm threshold requirement.

(3) MSL, Peak Temp. - The Moisture Sensitivity Level rating according to the JEDEC industry standard classifications, and peak solder temperature.

(4) There may be additional marking, which relates to the logo, the lot trace code information, or the environmental category on the device.

(5) Multiple Device Markings will be inside parentheses. Only one Device Marking contained in parentheses and separated by a "-" will appear on a device. If a line is indented then it is a continuation of the previous line and the two combined represent the entire Device Marking for that device.

(6) Lead finish/Ball material - Orderable Devices may have multiple material finish options. Finish options are separated by a vertical ruled line. Lead finish/Ball material values may wrap to two lines if the finish value exceeds the maximum column width.

Important Information and Disclaimer:The information provided on this page represents TI's knowledge and belief as of the date that it is provided. TI bases its knowledge and belief on information provided by third parties, and makes no representation or warranty as to the accuracy of such information. Efforts are underway to better integrate information from third parties. TI has taken and

continues to take reasonable steps to provide representative and accurate information but may not have conducted destructive testing or chemical analysis on incoming materials and chemicals. TI and TI suppliers consider certain information to be proprietary, and thus CAS numbers and other limited information may not be available for release.

In no event shall TI's liability arising out of such information exceed the total purchase price of the TI part(s) at issue in this document sold by TI to Customer on an annual basis.

TAPE AND REEL INFORMATION

QUADRANT ASSIGNMENTS FOR PIN 1 ORIENTATION IN TAPE

*All dimensions are nominal

Device	Package Type	Package Drawing	Pins	SPQ	Reel Diameter (mm)	Reel Width W1 (mm)	A0 (mm)	B0 (mm)	K0 (mm)	P1 (mm)	W (mm)	Pin1 Quadrant
TPS61230DRCR	VSON	DRC	10	3000	330.0	12.4	3.3	3.3	1.1	8.0	12.0	Q2
TPS61230DRCT	VSON	DRC	10	250	180.0	12.4	3.3	3.3	1.1	8.0	12.0	Q2
TPS61232DRCR	VSON	DRC	10	3000	330.0	12.4	3.3	3.3	1.1	8.0	12.0	Q2
TPS61232DRCT	VSON	DRC	10	250	180.0	12.4	3.3	3.3	1.1	8.0	12.0	Q2

TAPE AND REEL BOX DIMENSIONS

*All dimensions are nominal

Device	Package Type	Package Drawing	Pins	SPQ	Length (mm)	Width (mm)	Height (mm)
TPS61230DRCR	VSON	DRC	10	3000	367.0	367.0	35.0
TPS61230DRCT	VSON	DRC	10	250	210.0	185.0	35.0
TPS61232DRCR	VSON	DRC	10	3000	367.0	367.0	35.0
TPS61232DRCT	VSON	DRC	10	250	210.0	185.0	35.0

GENERIC PACKAGE VIEW

DRC 10

VSON - 1 mm max height

3 x 3, 0.5 mm pitch

PLASTIC SMALL OUTLINE - NO LEAD

This image is a representation of the package family, actual package may vary.
Refer to the product data sheet for package details.

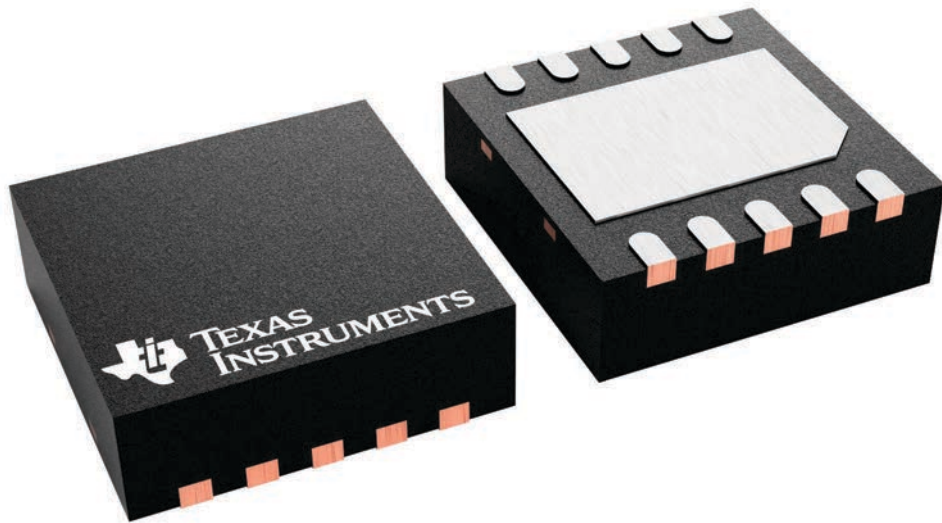

4226193/A

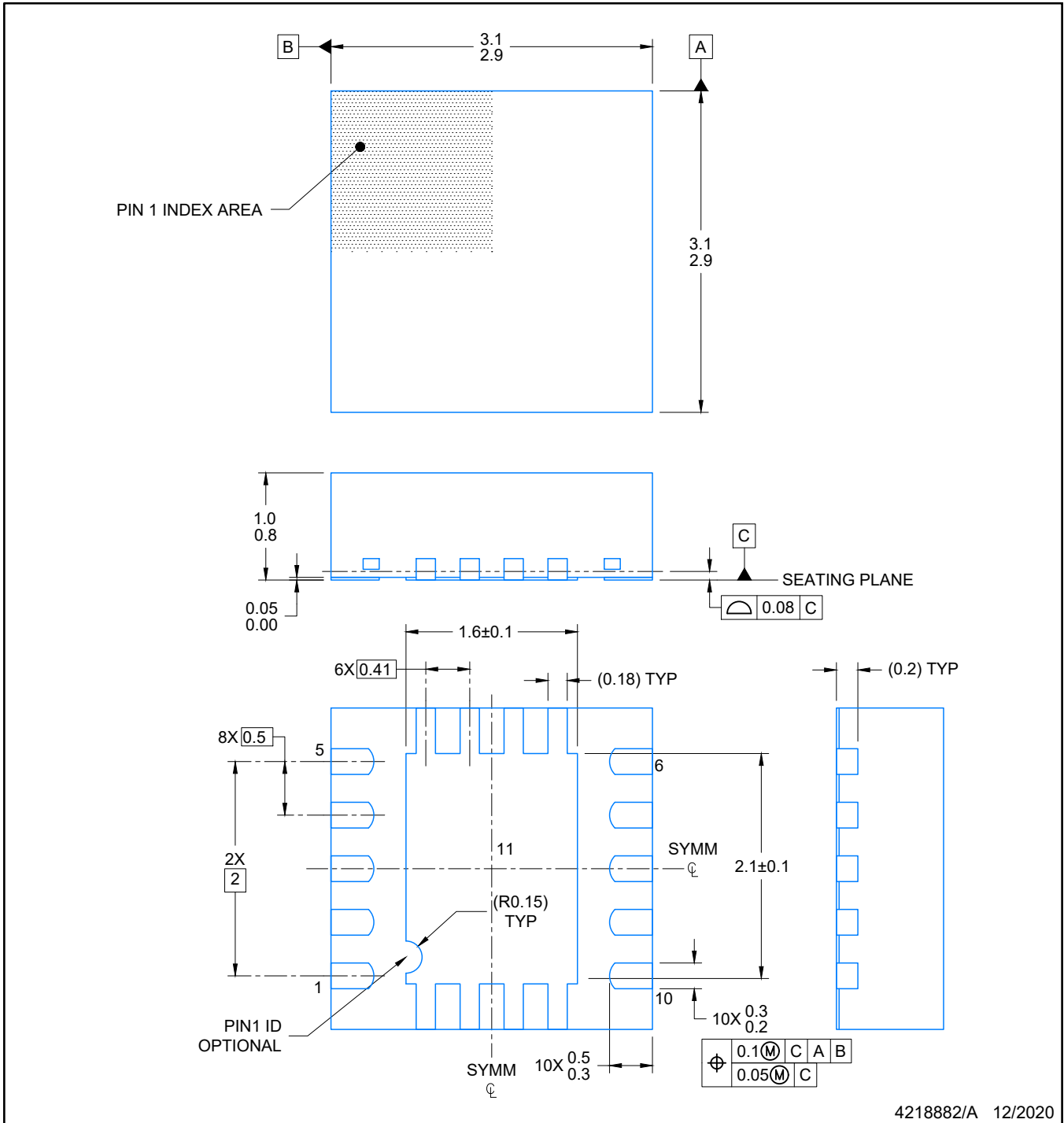

NOTES:

1. All linear dimensions are in millimeters. Any dimensions in parenthesis are for reference only. Dimensioning and tolerancing per ASME Y14.5M.
2. This drawing is subject to change without notice.
3. The package thermal pad must be soldered to the printed circuit board for optimal thermal and mechanical performance.

EXAMPLE BOARD LAYOUT

VSON - 1 mm max height

DRC0010G

PLASTIC QUAD FLATPACK-NO LEAD

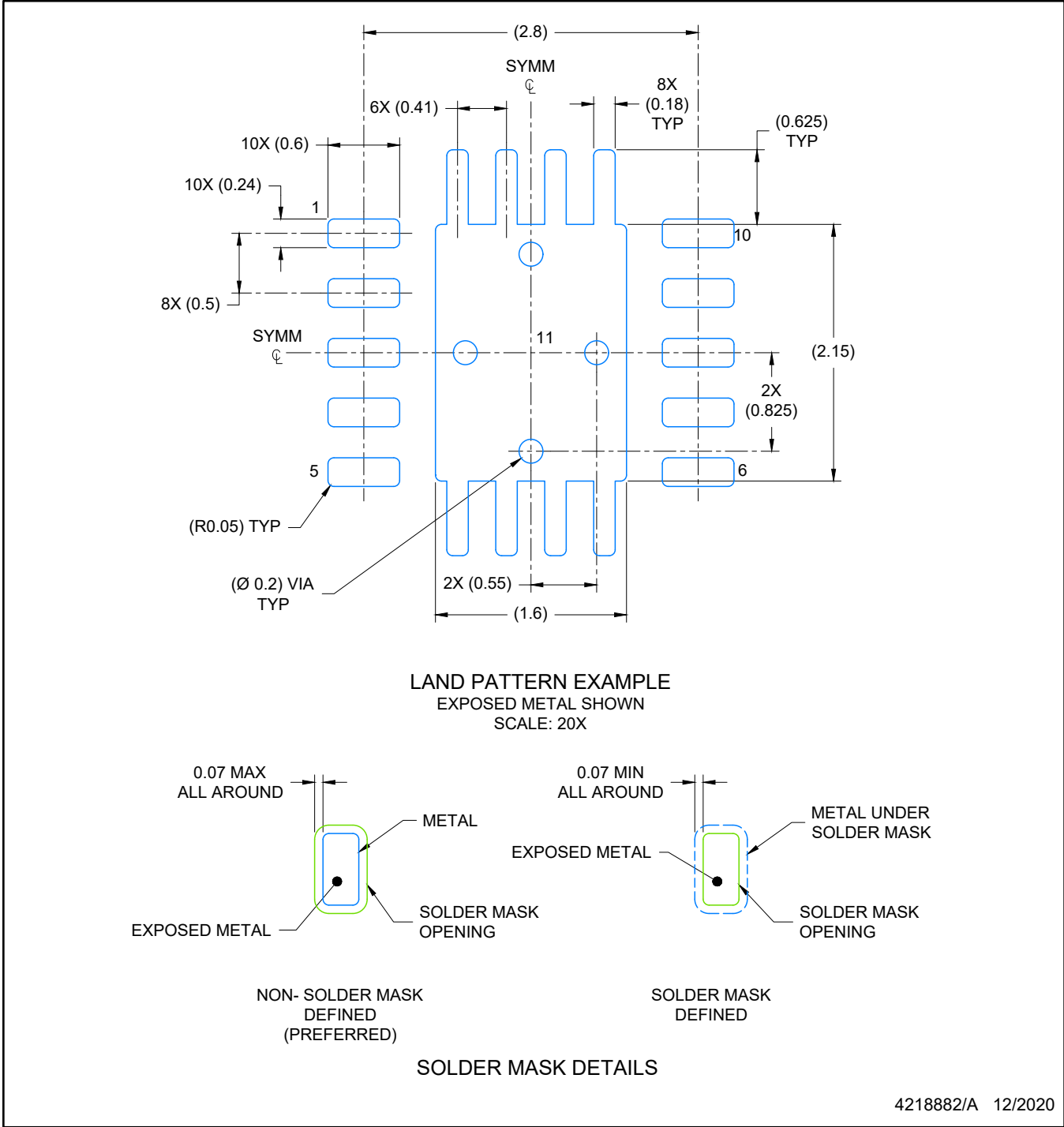

NOTES: (continued)

4. This package is designed to be soldered to a thermal pad on the board. For more information, see Texas Instruments literature number SLUA271 (www.ti.com/lit/slua271).
5. Vias are optional depending on application, refer to device data sheet. If any vias are implemented, refer to their locations shown on this view. It is recommended that vias under paste be filled, plugged or tented.

EXAMPLE STENCIL DESIGN

VSON - 1 mm max height

DRC0010G

PLASTIC QUAD FLATPACK-NO LEAD

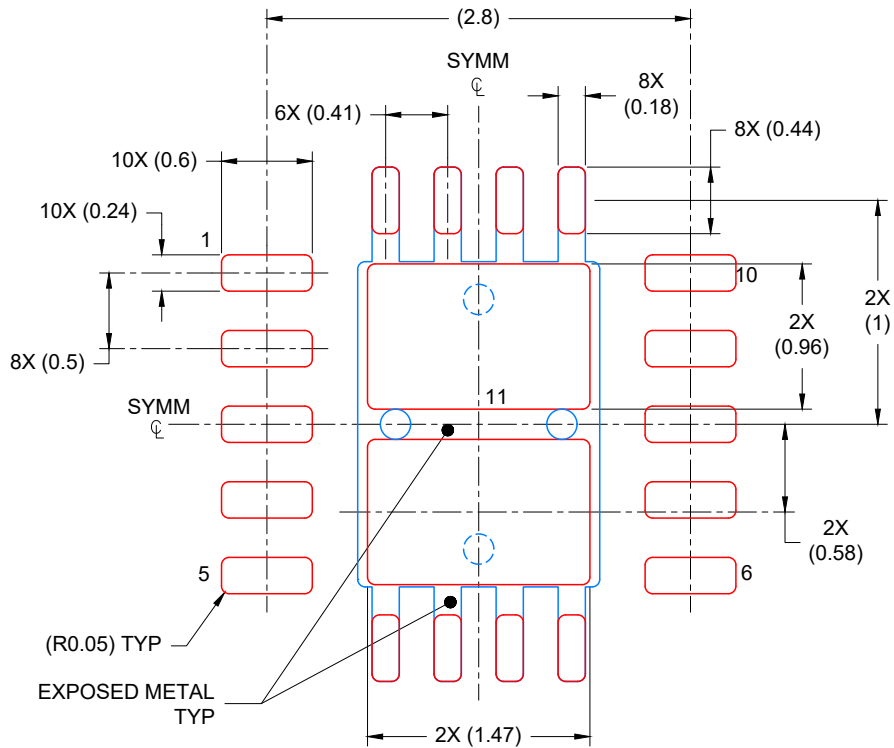

SOLDER PASTE EXAMPLE
BASED ON 0.1 mm THICK STENCIL

EXPOSED PAD
79% PRINTED COVERAGE BY AREA
SCALE: 20X

4218882/A 12/2020

NOTES: (continued)

6. Laser cutting apertures with trapezoidal walls and rounded corners may offer better paste release. IPC-7525 may have alternate design recommendations.

重要声明和免责声明

TI 均以“原样”提供技术性 & 可靠性数据（包括数据表）、设计资源（包括参考设计）、应用或其他设计建议、网络工具、安全信息和其他资源，不保证其中不含任何瑕疵，且不做任何明示或暗示的担保，包括但不限于对适销性、适合某特定用途或不侵犯任何第三方知识产权的暗示担保。

所述资源可供专业开发人员应用 TI 产品进行设计使用。您将对以下行为独自承担全部责任：(1) 针对您的应用选择合适的 TI 产品；(2) 设计、验证并测试您的应用；(3) 确保您的应用满足相应标准以及任何其他安全、安保或其他要求。所述资源如有变更，恕不另行通知。TI 对您使用所述资源的授权仅限于开发资源所涉及 TI 产品的相关应用。除此之外不得复制或展示所述资源，也不提供其它 TI 或任何第三方的知识产权授权许可。如因使用所述资源而产生任何索赔、赔偿、成本、损失及债务等，TI 对此概不负责，并且您须赔偿由此对 TI 及其代表造成的损害。

TI 所提供产品均受 TI 的销售条款 (<http://www.ti.com.cn/zh-cn/legal/termsofsale.html>) 以及 [ti.com.cn](http://www.ti.com.cn) 上或随附 TI 产品提供的其他可适用条款的约束。TI 提供所述资源并不扩展或以其他方式更改 TI 针对 TI 产品所发布的可适用的担保范围或担保免责声明。

邮寄地址：上海市浦东新区世纪大道 1568 号中建大厦 32 楼，邮政编码：200122

Copyright © 2020 德州仪器半导体技术（上海）有限公司